

Installation Guide

Version: 1.2

Date: Mar., 2014

I . Reference Tools for Installing the Door Lock



1 Hammer



2 Screwdriver



3 Chisel for wood working



4 Angle square



5 Percussion drill



6 Hole saw



7 Polisher



8 Rivet gun



9 Carpenter's pencil



10 Pliers

II . Quick Reference

A. Quick reference for Installation Guide

- Confirm the door information before installation, please see [III. Confirm the door information before installation](#);
- Install Lock Body, please see [IV. Install Lock Body](#);
- Confirm the length of Locking Bar, please see [V. Confirm the length of Locking Bar](#);
- Install the Front Panel Assembly, please see [VI. Install the Front Panel Assembly](#);
- Install Batteries, please see [VII. Install the Batteries](#);
- Install the Rear Panel Assembly, please see [VIII. Install the Rear Panel Assembly](#);
- Use Instruction, please see [IX. Use Instructions](#);
- The Basic Operation, please see [X. The Basic Operation](#);
- Routine Maintenance, please see [XI. Routine Maintenance](#).

B. List of Lock Accessories

1	Keyhole Cover	6	Screw (4 PCS)
2	Front panel Assembly	7	4 PCS AA Batteries
3	Silica gel backing plate	8	Rear panel assembly
4	Lock body	9	Screw (2PCS)
5	Back Lining Plate	10	Key (2PCS)

III. Confirm the door information before installation

1. Installation Requirements

This fingerprint lock is not configured with a handle, and the user can install it on the door as desired. The fingerprint lock is applicable to doors of 35-50 mm in thickness.

2. Make sure of the door opening directions and lock body directions

(1). Make sure of the door opening directions. The lock body's outside and inside can't be set contrary. Assume you are standing outside and facing a door and then there are four door opening directions: Left inward, left outward, right inward and right outward. Left inward/outward means the door swings inward/outward with hinges on the left; right inward/outward means the door swings inward/outward with hinges on the right, as shown in the following **Figure 1**:

(2). Make sure of the lock body directions. According to the door opening directions to make sure of the lock body directions, shown as the following **Figure 2**:

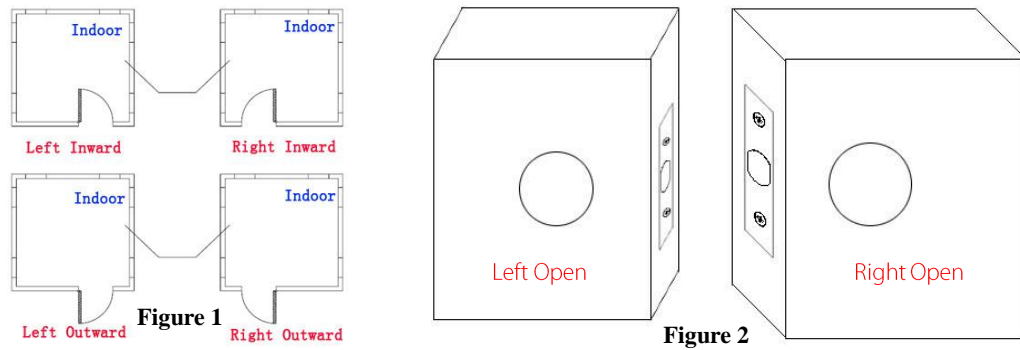

(3). To set the lock as "Left Open" or "Right Open" on the Rear panel Assembly, shown as **Figure 3**:

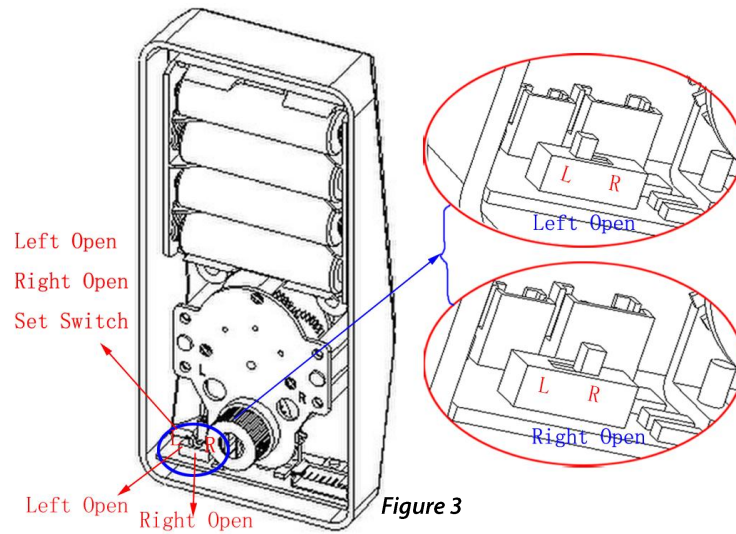

As shown in **Figure 3**, there has a "Left open/Right Open" set Switch on the Rear panel Assembly of the fingerprint lock. The user can turn the switch to the left side (L), namely set the door's opening directions as "Left Open"; if turn the switch to the right side (R), then set the door's opening directions as "Right Open".

Note. ① Before install the fingerprint lock, you must make sure of the door's opening direction as Left Open or Right Open at first; ② According to the door's opening direction, switch the "Left/Right Open" set switch to the corresponding position (Left Open, then switch to the left side; Right Open, then switch to the right side); ③ According to the door's opening direction to drill a hole and trough in the door, and then install the Lock Body.

(4). Install knob screw spacing, in order to protect the locking bar don't damage by greatly too forcibly knob lock, as shown in **figure 4**.

When set to left open the door, press the screw with hexagonal wrench shown in **figure 5-1**, screw down the screw on the marked L position hole with thread. When set to right open the door, press the screw with hexagonal wrench shown in **figure 5-2**, screw down the screw on the marked R position hole with thread.

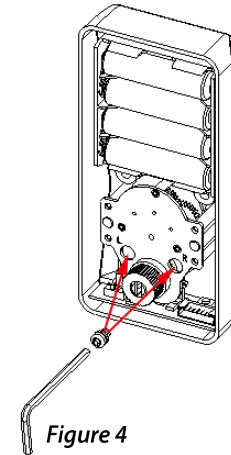

Figure 4

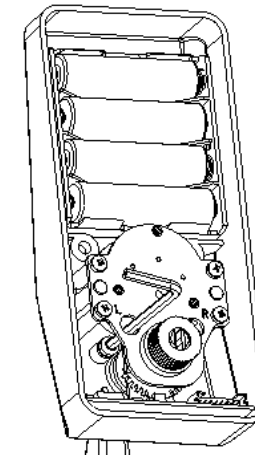

Figure 5-1

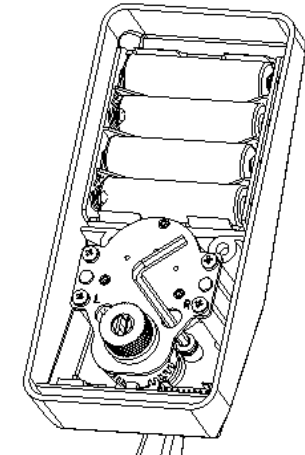

Figure 5-2

IV. Install Lock Body

1. Determine the installation height and installation location; stick the hole-drilling template to an appropriate location according to the door-opening mode, as shown in **Figure 6-1**.

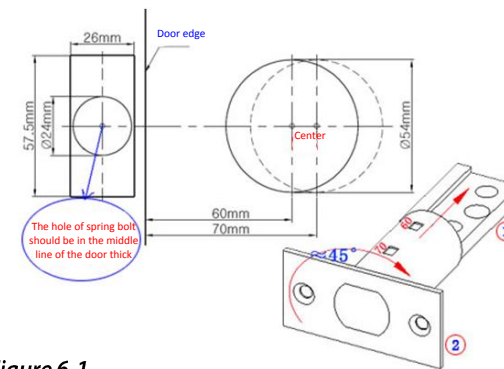

Figure 6-1

Figure 6-2

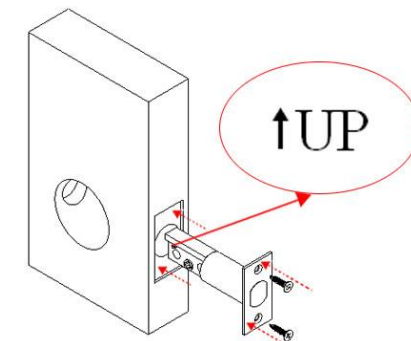



Figure 7

2. Insert the **Lock Body** into the matching **Hole Slot**, as shown in **Figure 7**.

 **Note:** There has a "↑UP" flag on the **Lock Body**. Before installing the **Lock Body**, confirm how to install it based on the tip flag.

Set the length of the **Lock Body** based on the distance from the **Door Edge** to the center of the circle (that is, the opening hole distance is about 60 mm or 70 mm, as shown in **Figure 6-1**).

The opening distance matching the default length of the lock body is 60 mm. If the distance of 70 mm is required, reset the length of the lock body in the following steps:

- (1). Hold the part ① of the **Lock Body**, rotate the part ② by 45°, and pull back part ②. As shown in **Figure 6-2**.
- (2). Rotate part ② by 45° in the other direction to make the card pillar of the **Lock Body** to be embedded into the matching card hole of 70 mm. That is, set the length of the **Lock Body** to 70 mm.

 **Note:** When you shorten the length of the **Lock Body**, perform the following steps:

- (1). Hold the part ①, rotate the part ② by 45°, and push part ② ahead. (2). Rotate part ② by 45° in the other direction to make the card pillar of the Lock Body to be embedded into the matching card hole of 60 mm.

3. After the procedure is completed, fix the **Lock Body** using a screwdriver, as shown in **Figure 8**. Insert the screwdriver into the cross-shaped hole of the **Lock Body**. When you rotate the cylinder clockwise, it springs out automatically, as shown in **Figure 9**. When you rotate the cylinder counterclockwise, it springs back automatically, as shown in **Figure 10**.

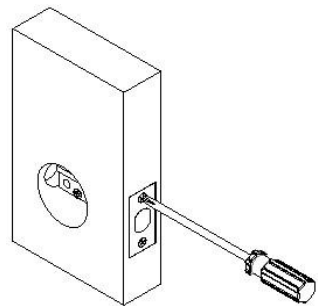

Figure 8

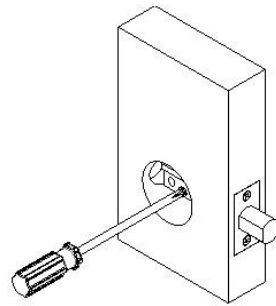

Figure 9

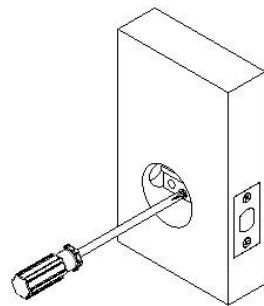

Figure 10

V. Confirm the length of Locking Bar

1. Install the **Front panel Assembly** of the lock onto the door (Please see [VI. Install the Front panel Assembly](#)). As shown in **Figure 11**:

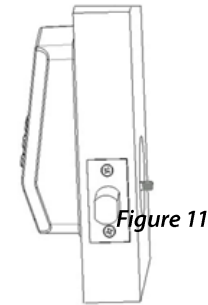

Figure 11

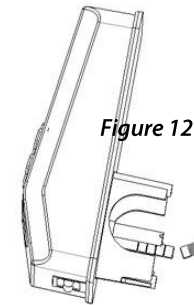

Figure 12

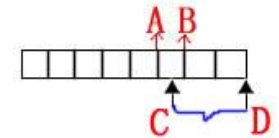

Figure 13

2. Check whether the **Locking Bar** is too long. If yes, take the **Front panel Assembly** off and cut away the excess part of the **Locking Bar** (see **Method for Cutting Locking Bar**). As shown in **Figure 12**.

Method for cutting Locking Bar. Suppose that the part of the **Locking Bar** that stretches out of the **Hole Slot** on the door is **CD**, as shown in **Figure 13**. Cut away the **Locking Bar** from **A** to ensure that the **Locking Bar** does not stretch out of the **Hole Slot**.

VI. Install the Front Panel Assembly

1. Install a **Silica gel backing plate** on the **Front panel Assembly** (moisture proof / waterproof). As shown in **Figure 14**.

Silica gel backing plate

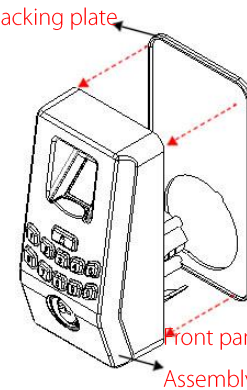

Figure 14

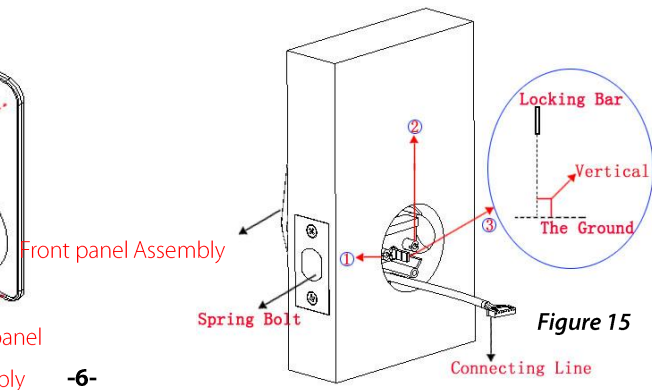

Figure 15

2. Stretch the **Spring Bolt** back to the **Lock Body** and pull the **Connecting Wire** out of the hole at the bottom of the **Lock Body**.

3. Install the **Front panel Assembly** into the matching **Hole Slot** on the door. (There are three holes on the **Lock Body**, as shown in the preceding figure. The cylinder on the fore plate composition must be pulled out from the cross-shaped hole of the **Lock Body** and the **Locking Bar** must be vertical to the ground.), as shown in **Figure 15**.

4. Install the **Back Lining Plate** to the mapping **Hole Slot**. Pull the **Connecting Wire** out of the **Oval-shaped Hole** of the **Back Lining Plate** (As shown in **Figure 16**) and fix the **Back Lining Plate** and **Front panel Assembly** using a screwdriver, as shown in **Figure 17**.

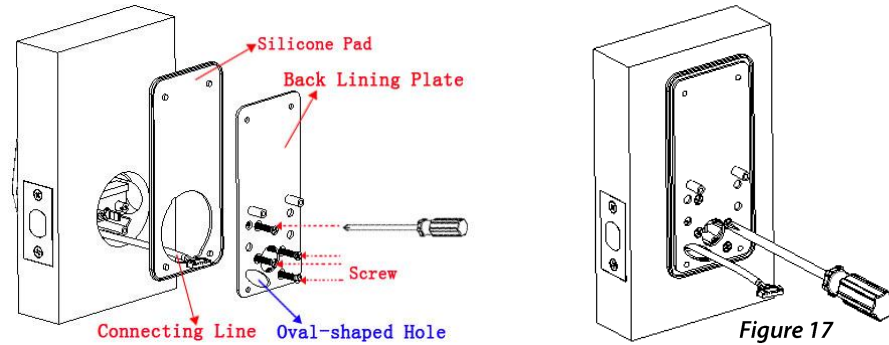

Figure 16

Figure 17

Select suitable screw	KM4*35 screw	Apply thick door 43-50mm
	KM4*25 screw	Apply thick door 35-43mm

VII. Install the Batteries

1. Prepare four AA batteries. You are advised to use new batteries with the same brand.
2. Put batteries into the **Rear panel Assembly** properly. As shown in **Figure 18-1** and **18-2**:

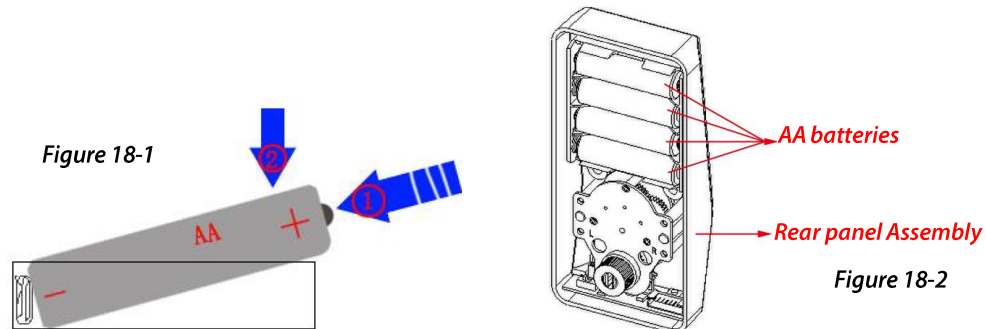

Figure 18-1

Figure 18-2

VIII. Install the Rear Panel Assembly

1. Pull the **Connecting Wire** into the **Wire Hole** of the **Rear panel Assembly**. As shown in **Figure 19**:

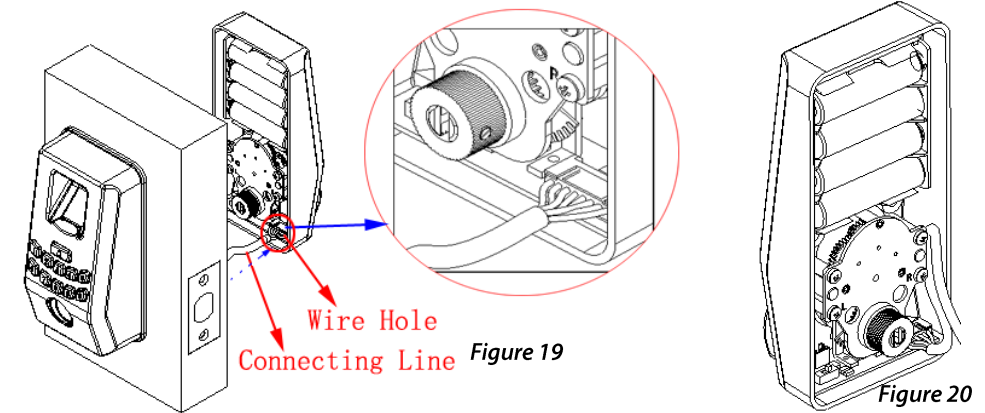

Figure 19

Figure 20

2. Tuck up the **Connecting Wire**, place the **Connecting Wire** in the cracks near the motor components for further **Rear panel Assembly** installation. As shown in **Figure 20**.

3. Cover the **Silica gel Backing Plate** onto the **Rear panel Assembly**, turn the **Lock Button** to make the **Hole Slot** vertical to the ground, and insert **Locking Bar** into the **Hole Slot**, as shown in **Figure 21**. In this case, when you turn the **Lock Button**, the bolt can sprung out or back automatically.

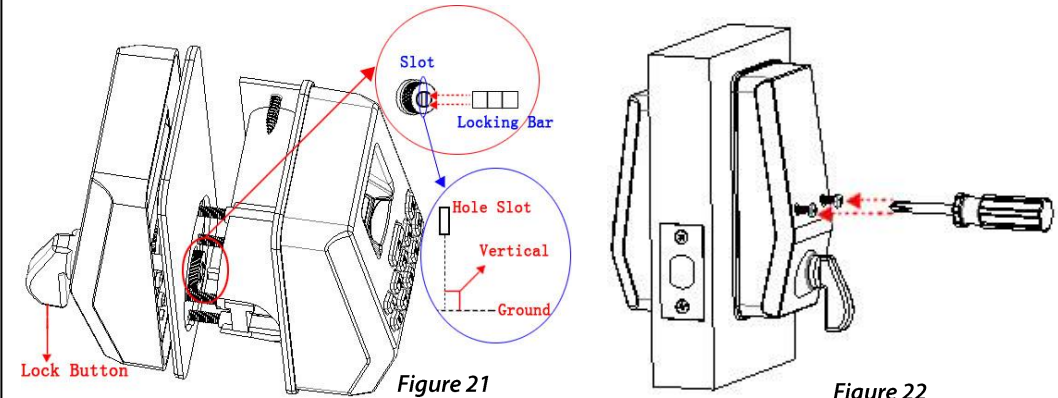

Figure 21

Figure 22

4. Push the **Rear panel Assembly** ahead to ensure that it can cover the whole **Back Lining Plate**. Install screws and fix them using a screwdriver. As shown in **Figure 22**.

IX. Use Instructions

1. Panel Description

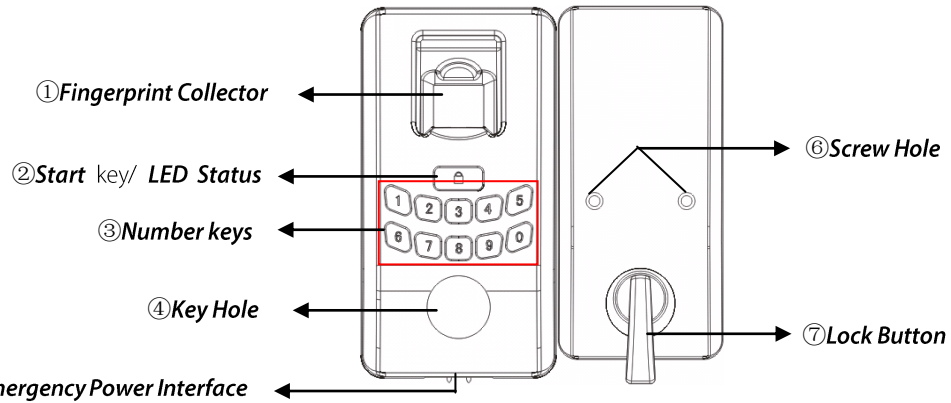

2. Precautions

(1). After the fingerprint lock is installed, the lock is in the test state, and therefore any fingerprints and passwords can open the lock. You must modify the Master Pass Code (MPC). The lock can be used normally only after the User ID of an administrator is entered. If the MPC is not modified, the other functions of the system except for the initialization system are not available in the management mode. If no administrator is registered, ordinary users cannot also be registered.

(2). Do not remove batteries when matching, enrolling or deleting fingerprints because the sudden power-down may result in data loss of fingerprint locks. Prior to removing batteries, make sure the fingerprint lock is not in working state.

(3). It is recommended to replace the fingerprint lock batteries at least once every six months to avoid damaging the circuit due to the battery leakage. Do not use batteries with poor quality.

3. LED Backlight Indicators

The LED Backlight Indicators content three colors: Red, Green and Blue.

➤ **The general rule:**

Successful = 1 Long Beep / Green LED is on for 1 second.

Failed = 2 Short Beeps / Red LED is on for 1 second.

➤ **Verify State:** Green LED flash by second.

➤ **Management Mode:** Blue LED is on.

4. Unlock with an Emergency Mechanical Key

You can open the door using an emergency mechanical key in case the electronic component does not operate.

- ① Use your fingernails or a hard chip to take down the lock cover.
- ② Insert the emergency key into the keyhole and rotate 90° to unlock.

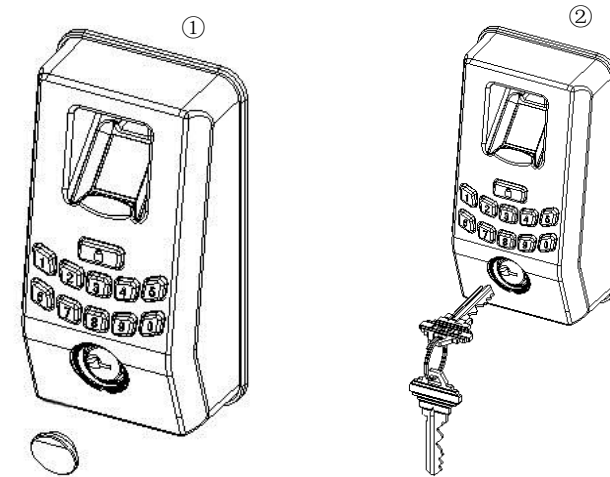

5. Battery Low Voltage Protection

When the battery is low, there are alarm signals to warn users to change the battery as follows:







(1). When the battery voltage is lower than 4.8V, the buzzer will make short sharp sounds for five times when starting the machine. Users can unlock it normally but fail to enter the administrative mode.

(2). When the battery voltage is lower than 4.5V, the buzzer will make short sharp sounds for five times, and then the machine will be switched off automatically.



 **Note:** When the low-voltage alarm occurs, please change the battery in time to avoid the impact on the work of the fingerprint lock. Avoid losing data caused by instable power supply (It is suggested to change the battery immediately when the battery voltage is lower than 4.8V).

X. The Basic Operation

I. Change Master Pass Code (MPC)

1. Press  key to start lock, and then enter the Verify State. The LED flashes green light.
2. Press and hold the  key until you hear 1 long beep and the Green LED put out, and then the Keypad area Flashes Blue light. Press number key of the lock to input the default MPC "98989", and then press  key to enter the Management Mode. The green LED put out and the Numpad area's blue light will be on.
3. Press "5" key on the lock and enter the new 5 digits MPC, then press the  key to confirm. Enter the new MPC once again then press the  key to confirm. Once you hear 1 long beep and the  key flashes green, namely you have successfully changed the MPC code.

II. Enroll an Administrator

1. Press  key to start lock, and then enter the Verify State.
2. Press and hold the  key until you hear 1 long beep, enter the 5 digits MPC, and then press  key to enter the Management Mode.
3. Press "9" on the lock to enter the Enroll Administrator Mode.

➤ Enroll a Fingerprint Administrator User

 **Note:** 1-3 steps are same as above. Here is no longer to restatement.



4. After enter the Enroll Administrator Mode, press number keys of the lock to enter 3 digits user ID, and then press  key to confirm.

 **Note:** The administrator User's ID must between "995" and "999".

5. Press finger in the scanner area properly, and repeat it for three times, until you hear one long beep and LED flashes Green.

➤ Enroll a Password Administrator User

 **Note:** 1-3 steps are same as above. Here is no longer to restatement.





4. After enter the Enroll Administrator Mode, enter 3 digits user ID, press  key to confirm.
5. Press 4 digits user password and press  key to confirm, and then enter the 4 digits user password once again and press  key to confirm, until you hear one long beep and LED Flashes Green (If it fails to register - it will

give 2 short beeps and LED will flash red).

 **Note:** ① If Pass code does not match or input the wrong digit password, then you have two times to try again. If your input the wrong at the third time, then it will prompt fail registration. In this case you will need to follow step 1 to operate again. ② If successful, it will automatically exit the Enroll Administrator Mode. ③ Press and hold "0" key, can exit anytime. ④ If you want to enroll more administrator user, and then repeat the step 1-5.

III. Enroll an Ordinary User



➤ Enroll a Fingerprint Ordinary User

1. Press  key to start the lock and enter the Verify State.
2. There have two methods to enter the Management Mode: ① Press and hold the  key until you hear 1 long beep, enter the 5 digits MPC, and then press  key to enter the Management Mode. ② Verify the registered administrator's password and fingerprint to enter the Management Mode.
3. Press "1" to enter the Enroll Ordinary User's Fingerprint Mode.
4. Input 3 digits User ID, then press  key to confirm.



 **Note:** The ordinary users' ID must between "001" and "994".

5. Press finger in the scanner area properly, and repeat it for three times, until you hear one long beep and LED flashes Green, namely enrollment successful.

➤ Enroll a Password Ordinary User





1. Press  key to start the lock and enter the Verify State. Enter the Management Mode; see the methods on how to enter the management mode in the **Enroll a Fingerprint Ordinary Users**.
2. Press "2" on the lock to enter the Enroll Ordinary User's Password Mode.
3. Input 3 digits User ID, and press  key to confirm.

 **Note:** The ordinary users' ID must between "001" and "994".





4. Input 4 digits user password, press  key to confirm. Enter the 4 digit user password once again and press  key to confirm until you hear one long beep and LED flashes Green. The Keypad area's blue LED pulls out and the  key lights green LED, namely register successful.



IV. User Verification

➤ The Fingerprint Verification

1. Press  key to start the lock and enter the Verify State. The **Fingerprint Collector** is in active state.
2. Press finger in the fingerprint scanner area properly, until you hear one long beep, namely collect successful.
(1) If verify successful, the buzzer will give a long beep and unlock automatic, the green LED and the **Fingerprint Collector** will put out, the Green LED at  key will light for 3 seconds, at this moment you can press  key to lock
(2) If verification failed. The buzzer will give two short beeps, the red LED at  key will light for 3s, then the green LED will flash, the user can use fingerprint to verify again until verify successful.





➤ The Password Verification

1. Press  key to start the lock and enter the Verify State.
2. Press number key of lock to input the correct 4 digits password, and press  key to confirm.
(1) If the password is correct, then verify successful, the buzzer will give a long beep and unlock automatic, the green LED at Fingerprint Collector will put out, the Green LED at  key will light for 3s, at this moment you can press the  key to lock.
(2) If the password is wrong, then the verification failed. The buzzer will give two short beeps, the RED LED at  key will light for 3s, then the green LED will flash, the user can input password to verify again until verify successful.

 **Note:** After successful verification, the lock is in unlocking state. If you want to lock, press  key to start the lock, and then press this key again to lock and power off.

V. Delete User





➤ Delete a user

1. Press  key to start the lock and enter the Verify State. See the methods on how to enter the management mode in the **Enroll a Fingerprint Ordinary Users**.
2. Press "3" on the lock to enter the Delete User Mode.
3. Press number key of the lock to input the User's ID which one you want to delete, and then press  key to confirm. Input the user ID again, and press  key to confirm, the buzzer will give a long beep, the  key lights green light, namely successful delete the user.

4. After deleting the user, you can restart the fingerprint lock and verify the deleted user's fingerprints or password again to check whether the user is deleted for sure.

 **Notice:** The administrator can't delete itself and the last administrator.

➤ Delete All Ordinary Users

1. Press  key to start the lock and enter the Verify State. See the methods on how to enter the management mode in the **Enroll a Fingerprint Ordinary Users**.
2. Press "6" on the lock to enter the Delete All Ordinary User Mode.
3. Input "000" and press  key to confirm, then input "000" again and press  key to confirm. The buzzer will give a long beep, the  key flash green light, namely successful delete all users.

 **Notice:** The operation can only delete ordinary users. If you want to delete administrator, you should do reset operation.

XI. Routine Maintenance

1. The lock surface is forbidden to contact corrosive substances. Otherwise, the protective layer of the lock surface may be damaged, and therefore the glossiness of the lock surface may be decreased. To keep the lock surface glossy, use the furniture polish wax to polish the lock surface regularly.
2. Use the cloth to clean dirt after the fingerprint collector is used for long time.
3. Change batteries in time when the alarm on the low power rings. You must replace the four old batteries with four new batteries of the same brand (the alkaline battery of 1.5 V) once.
4. Regularly check whether screws are loose.