

2.8 inch Multi-Biometric Access Control Quick Start Guide

Version: 1.0

1. Overview

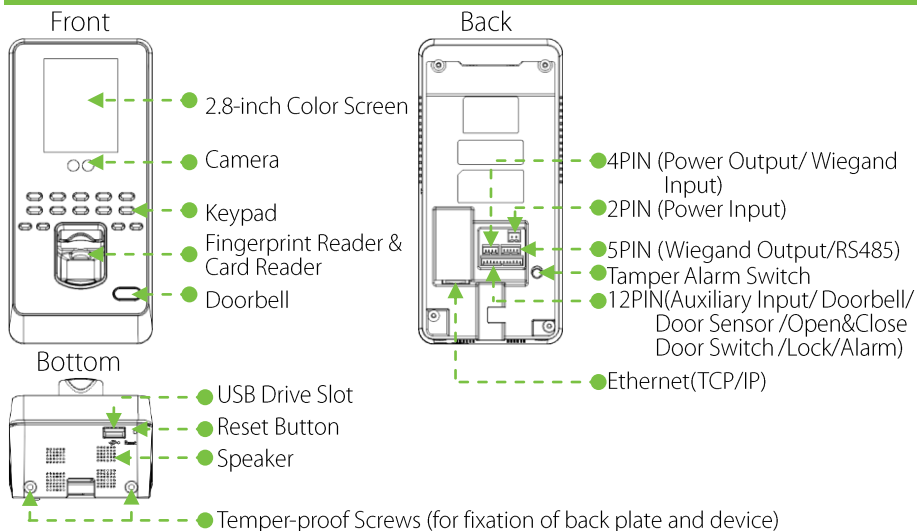

Note: Card swiping is an optional function.

2. Installation on Wall

Insert cables to connectors before installation.

1. Put the mounting template sticker onto the wall, and drill holes according to the symbols.
2. Install the device onto the back plate (or optional cable distribution plate).
3. Fix the back plate onto the wall.
4. Fix the device on the back plate with temper-proof screws.

Note: For user heights between 150CM to 180CM, it is recommended to install the device at 115CM above ground (may be modified according to user average height).

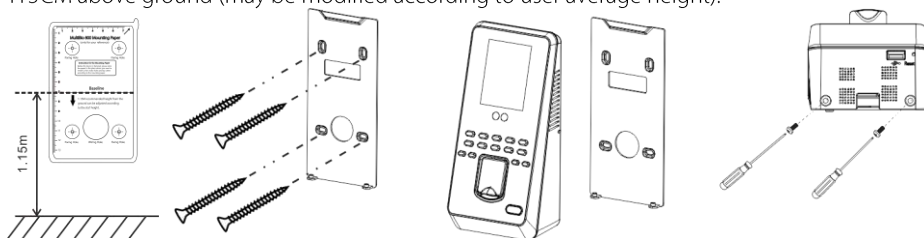

3. Cautions on Using Face Recognition Device

1). Recommended Standing Position

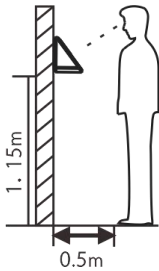

For user heights between 150CM to 180CM, it is recommended to install the device at 115CM above ground (may be modified according to user average height).

a. Recommended Registration and Verification Position

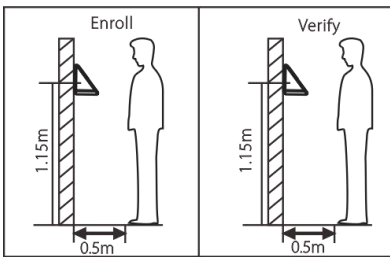

Recommended Procedure (as shown in left image): During registration and verification procedures, the position of device should not be changed to prevent deduction of verification preciseness. If it is necessary to move the device, its vertical height should not be changed.

b. Factors affecting the preciseness of verification

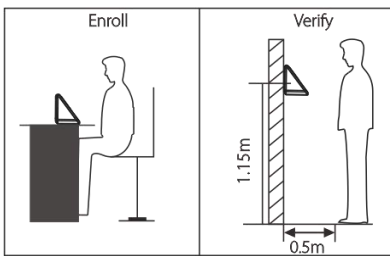

Non-identical registration and verification gestures

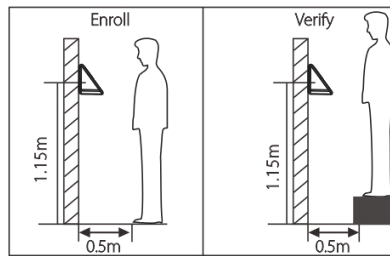

Non-identical registration and verification heights

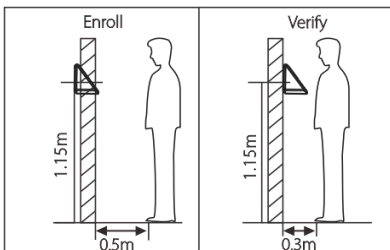

Non-identical registration and verification distance from device

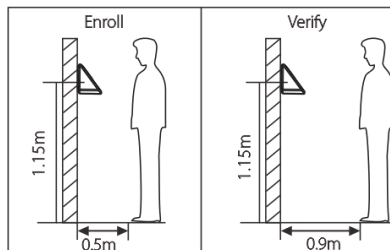

Non-identical registration and verification distance from device

2). Registration

- a. During registration, it is required to adjust your upper body to fit your eyes into the green frame in the screen.
- b. During verification, it is required to show your face in the middle position of the screen and fit your face into the green frame in the screen.



4. Access Control System Diagram

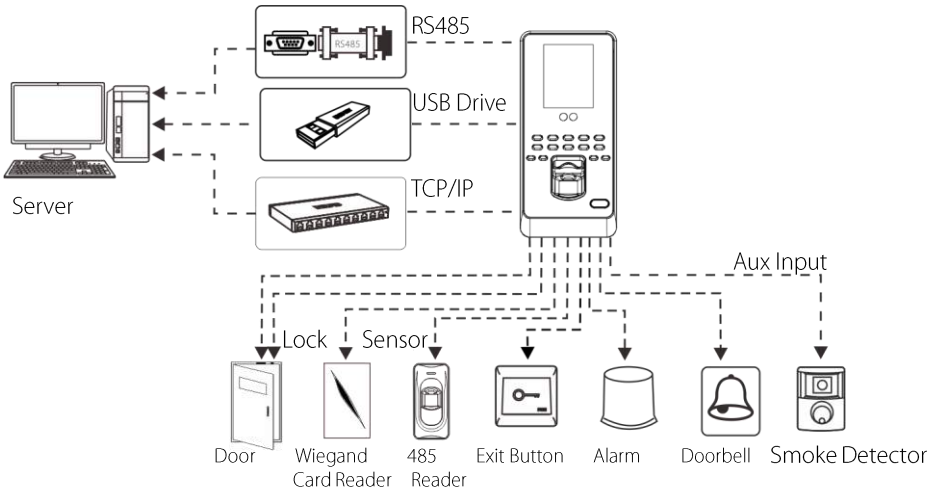

5. Power Connection

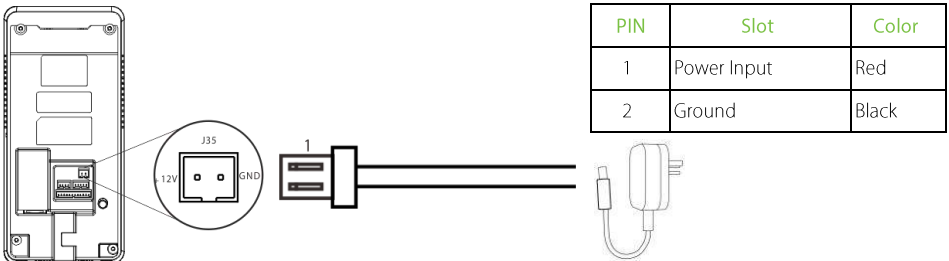

Recommended Power Supply: 12V±10%, Voltage >500mA.

If it is necessary to share power supply with other devices, the recommended power supply should be greater than actual work voltage.

6. Software Connection via Ethernet

To connect device to computer software via Ethernet, please refer to the diagram shown below:

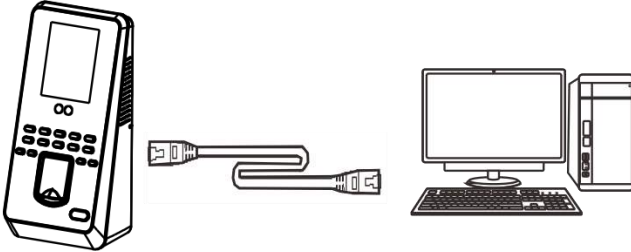

IP Address: 192.168.1.201
Subnet Mask: 255.255.255.0

IP Address: 192.168.1.124
Subnet Mask: 255.255.255.0

7. Exit Button

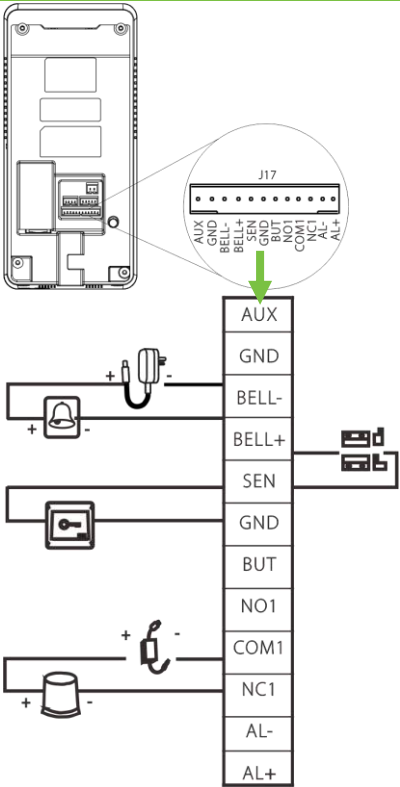

PIN	Slot	Color
1	Auxiliary Input	Brown
2	Ground	Purple
3	Doorbell	Green
4	Doorbell	Orange
5	Door Sensor	Yellow
6	Ground	Red
7	Exit Button	Blue
8	Normal Open	White
9	Common	Black
10	Normal Close	Grey
11	Alarm	Black
12	Alarm	Red

8. Connection to 485 Reader

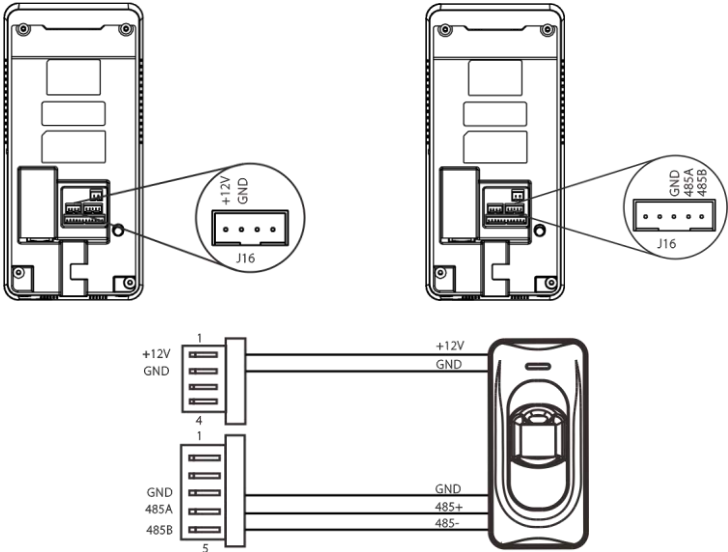

Activating 485 Reader Function

1. Switch off RS485 Serial Communication Function: Pres M/OK > Communication Setting > Serial Setting > RS485, Press M/OK to switch off RS485 function. (RS485 Serial Communication function must be switched off in order to display 485 Reader function).
2. Switch on 485 Reader function: Press M/OK > Access Control Management > Access Control Parameters > 485 Reader, select [Master] or [Slave] device.

9. Connection to Wiegand Card Reader

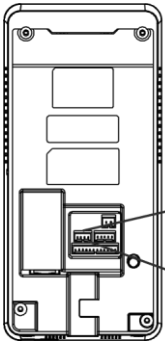

PIN	Slot	Color
1	Power Input	Red
2	Ground	Black
3	Wiegand Input	White
4	Wiegand Input	Green

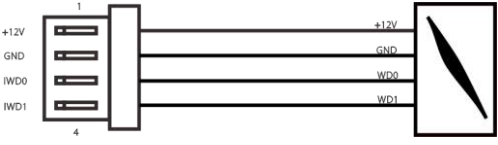

10. Date & Time Setting

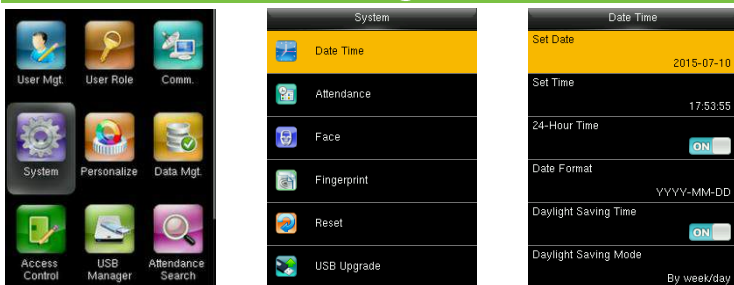

Press M/OK > Setting > Date & Time to set date and time.

11. Add User

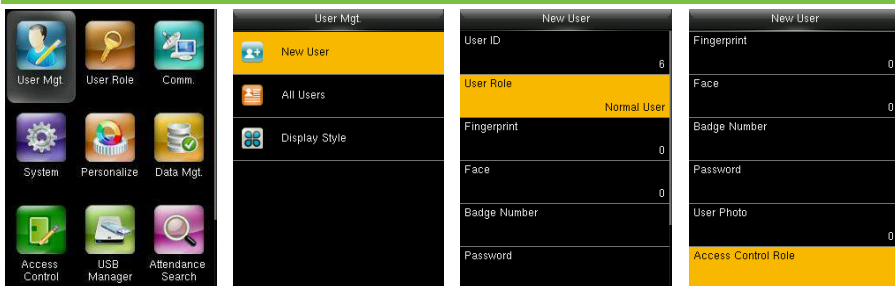

Press M/OK > User Management > Add User to set User ID, Authorities (Admin / User), Fingerprint, Face, Card and Image Registration, Password and Access Control Authorities.

Add Admin: Select Admin in Authorities.

Add User: Select User in Authorities.

12. Setting Network Parameters

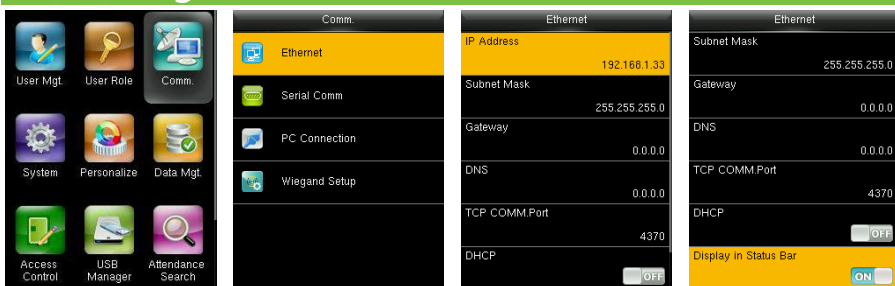

Press M/OK > Communication Setting > Network Setting.

The Parameters are by default set. Please Modify according to actual network and your personal needs.

IP Address: 192.168.1.201 is default.

Subnet Mask: 255.255.255.0 is default.

Gateway: 192.168.1.254 is default.

DNS: 0.0.0.0 is default.

TCP Communication Port: Default 4370

DHCP: Dynamic Host Configuration Protocol, which is to dynamically allocate IP addresses for client via server. If DHCP is enabled, IP cannot be set manually.

Display in Status Bar: To enable or disable displaying Network Connection Icon in Status Bar.

13. Access Control Setting

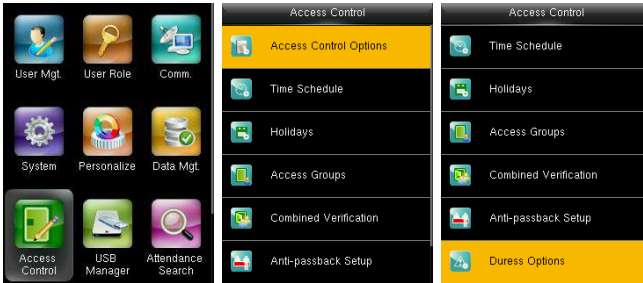

Press M/OK > Access Control Management.

The access time should fall into either the user's individual time zone or group time zone.

User's group must be in the access combo (when there are other groups in the same access combo, verification of members of those groups is also required to unlock the door).

Access Control Parameters: To set Locks and related devices' parameters.

Time Duration: To set minimum time units of access control.

Holidays: to set holiday access control and access time.

Access Control Group: To management personnel groups. The persons from groups may use default time duration or independently set time durations.

Anti-passback Setup: To prevent passing back which causes risks to security. Once enabled, entry and exit records must be matched in order to open door. Entry anti-passback, exit passback and entry & exit anti-passback functions are available.

Duress Alarm: If users unlock the door under threat, the device will open the door, meanwhile send signals to the backstage to trigger the alarm.

14. Auxiliary Input Setting

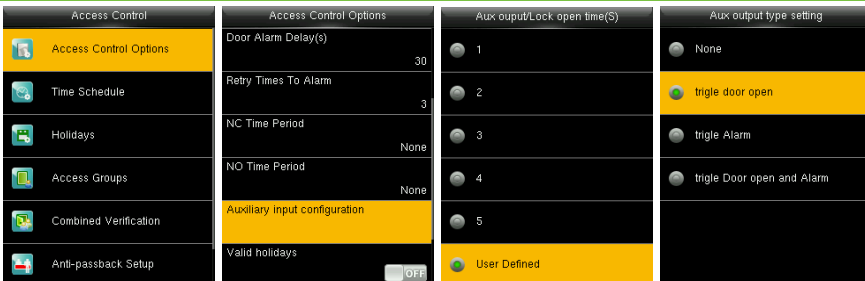

Press M/OK > Access Control Management > Access Control Parameters > Auxiliary Input Function Setting.

- Auxiliary Output Access Time: It is defined as the time interval between the lock receiving signals and automatically closing under Normal Closed mode.

Auxiliary Output Types

Triggering Access: The lock will turn to Normally Open after the device receives signals.

Triggering Alarm: The alarm will be triggered after the device receives signals.

Triggering Access & Alarm: The lock will turn to Normal Open and the alarm will be triggered after the device receives signals.

15. Turning Off Promotional Display

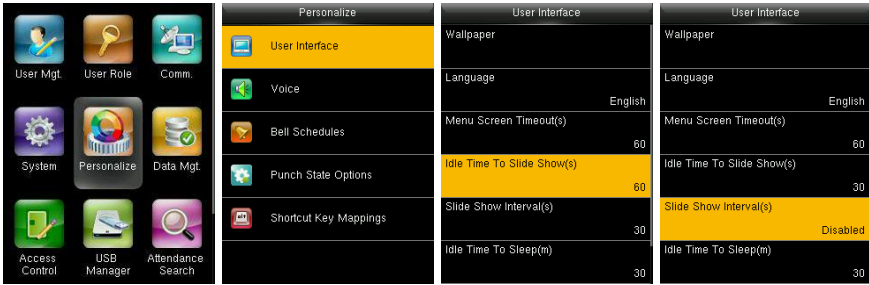

Press M/OK → Custom Settings → Interface Settings, to set the Promotional Display Waiting Time (s) to [Off], or set the Promotional Display Circulating Interval (s) to [Off].

16. Troubleshooting

1. Fingerprint sensor is not able to read and verify the fingerprint effectively
 - Check whether the finger is wet, or the fingerprint sensor is wet or dusty.
 - Clean the finger and the fingerprint sensor and try again.
 - If the finger is too dry, blow air onto it and try again.
2. "Invalid time zone" is displayed after verification
 - Contact Administrator to check if the user has the privilege to gain access within that time zone.
3. Verification succeeds but the user cannot gain access
 - Check whether the user privilege is set correctly
 - Check whether the lock wiring is correct
4. The Tamper Alarm rings
 - To cancel the triggered alarm mode, reinstall the device properly.