

QUICK START GUIDE

Applicable Models: inPulse, inPulse+

Version: 1.1

Date: Dec, 2015

Green
Label

Safety Precautions

Before installation, please read the following safety precautions for user safety and to prevent product damage.



Do not install the device in a place subject to direct sun light, humidity, dust or soot.



Do not place a magnet near the product. Magnetic objects such as magnet, CRT, TV, monitor or speaker may damage the device.



Do not place the device next to heating equipment.



Do not to let liquid like water, drinks or chemicals leak inside the device.



Do not let children touch the device without supervision.



Do not drop or damage the device.



Do not disassemble, repair or alter the device.



Do not use the device for any purpose other than those specified.



Clean the device often to remove dust on it. In cleaning, do not splash water on the device but wipe it out with smooth cloth or towel.

Contact your supplier in case of a problem!

Device Overview

★Not all products have fingerprint and finger vein functions, the real product shall prevail.

❖ inPulse+

Front

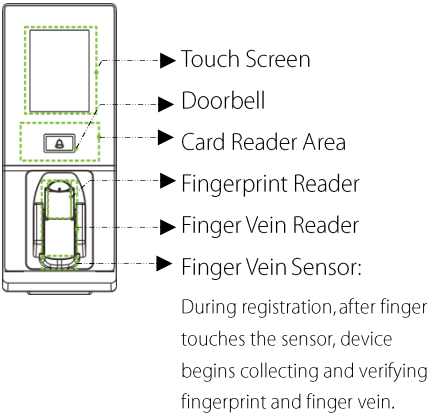

Left Side

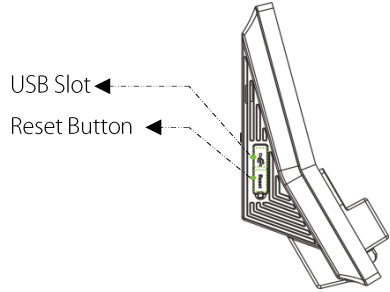

❖ inPulse

Front

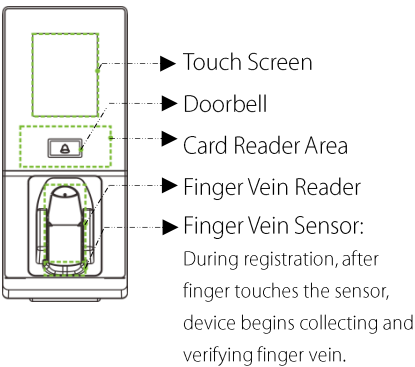

Left Side

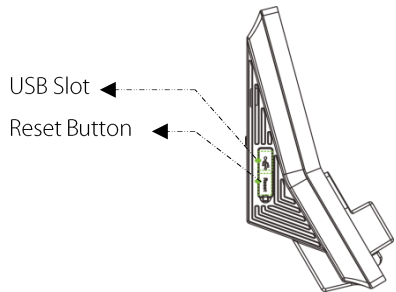

Device Overview

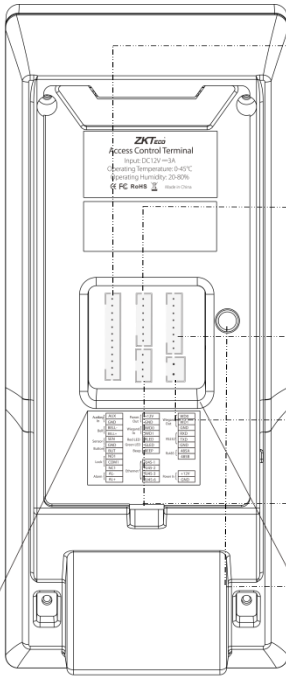

- Auxiliary In
- Bell
- Sensor
- Button
- Lock
- Alarm
- Power Out
- Wiegand In
- LED, Beep
- Wiegand Out
- RS232
- RS485
- Power In

Auxiliary In	AUX	Power Out	+12V	Wiegand Out	WD0
	GND		GND		WD1
Bell	BELL-	Wiegand In	IWD0	RS232	RXD
	BELL+		IWD1		TXD
Sensor	SEN	Red LED	RLED	RS485	GND
	GND	Green LED	GLED		485A
Button	BUT	Beep	BEEP	485B	
	NO1				
Lock	COM1	Ethernet	RJ45-1	Power In	+12V
	NC1		RJ45-2		GND
Alarm	AL-		RJ45-3		
	AL+		RJ45-6		

Device Dimensions & Installation

❖ Product Dimensions

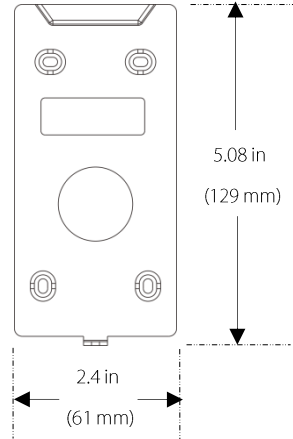
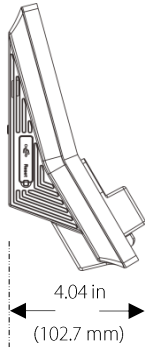
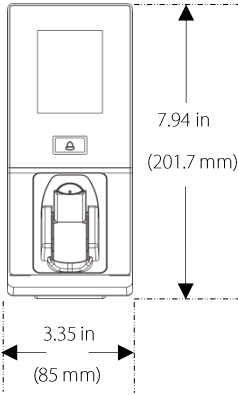

❖ Mounting the Device on Wall

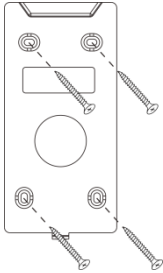

- 1 Fix the back plate onto the wall using wall mounting screws.

Note: We recommend drilling the mounting plate screws into solid wood (i.e. stud/beam). If a stud/beam cannot be found, use supplied drywall plastic anchors.

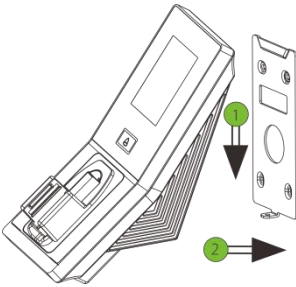

- 2 Insert the device to back plate.

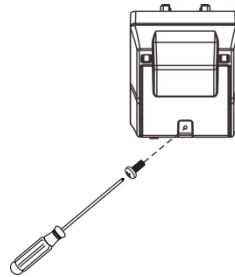

- 3 Use security screws to fasten the device to back plate.

Power Connection

❖ Without UPS

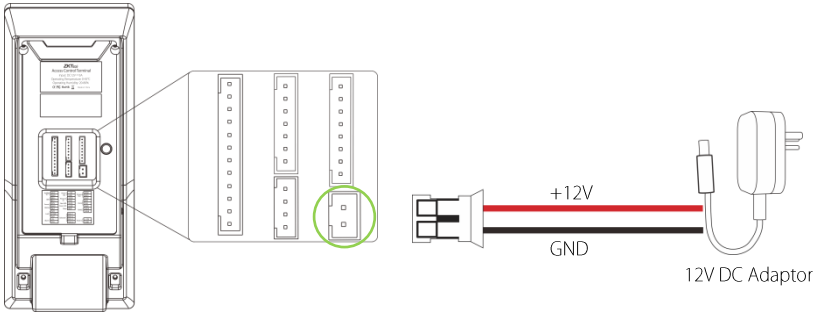

❖ With UPS (Optional)

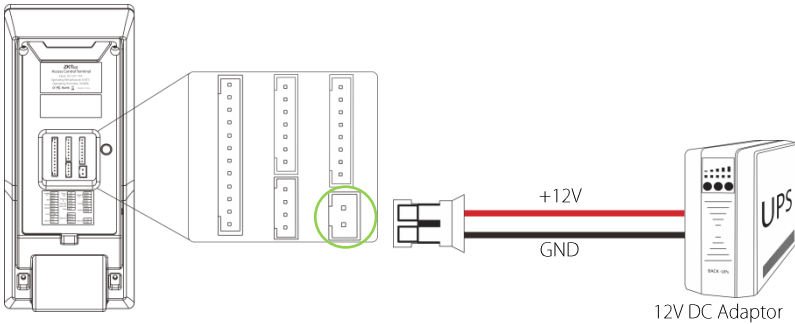

❖ Recommended Power Supply

- 12V±10%, at least 500MA.
- To share the power with other devices, use a power supply with higher current ratings.

Ethernet Connection

❖ LAN Connection

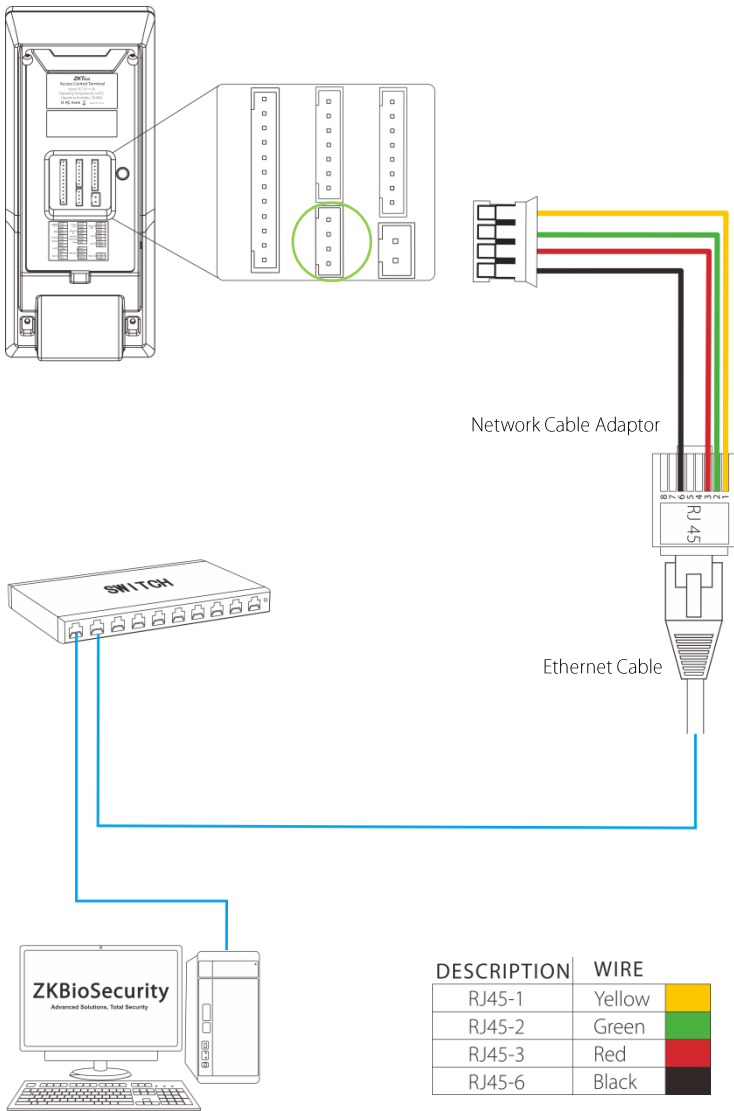

Note: The device can be connected to PC directly by Ethernet cable.

Lock Relay Connection

❖ Device Not Sharing Power with the Lock

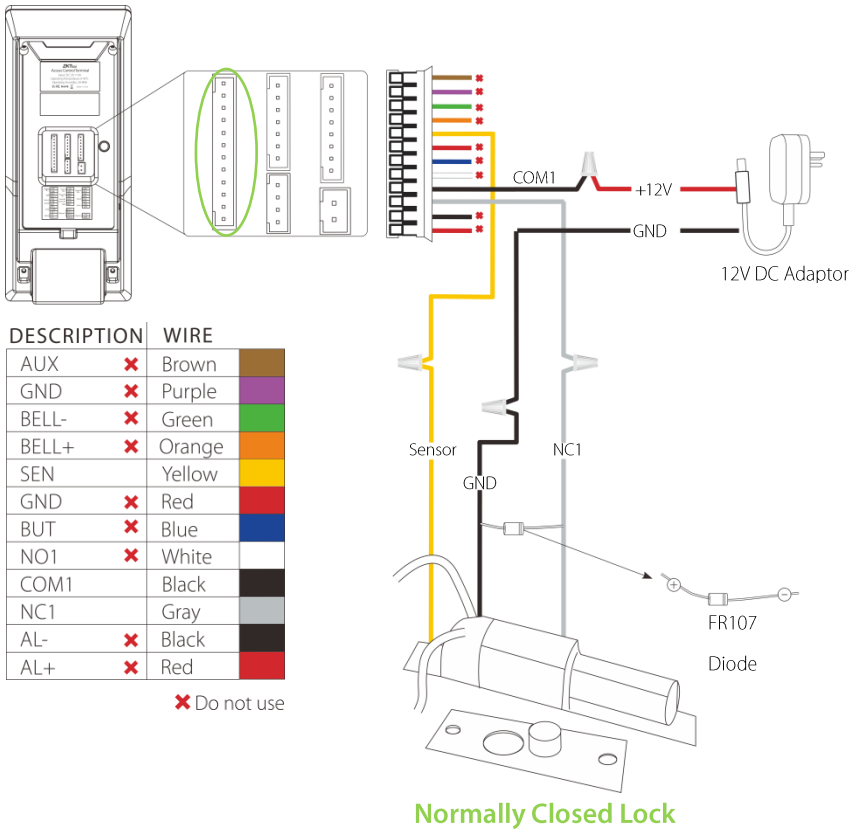

Notes:

1. The system supports **NO LOCK** and **NC LOCK**. For example the **NO LOCK** (normally opened at power on) is connected with '**NO1**' and '**COM1**' terminals, and the **NC LOCK** (normally closed at power on) is connected with '**NC1**' and '**COM1**' terminals.
2. When electrical lock is connected to the Access Control System, you must parallel one FR107 diode (equipped in the package) to prevent the self-inductance EMF from affecting the system.

⚠️ Do not reverse the polarities.

Lock Relay Connection

❖ Device Sharing Power with the Lock

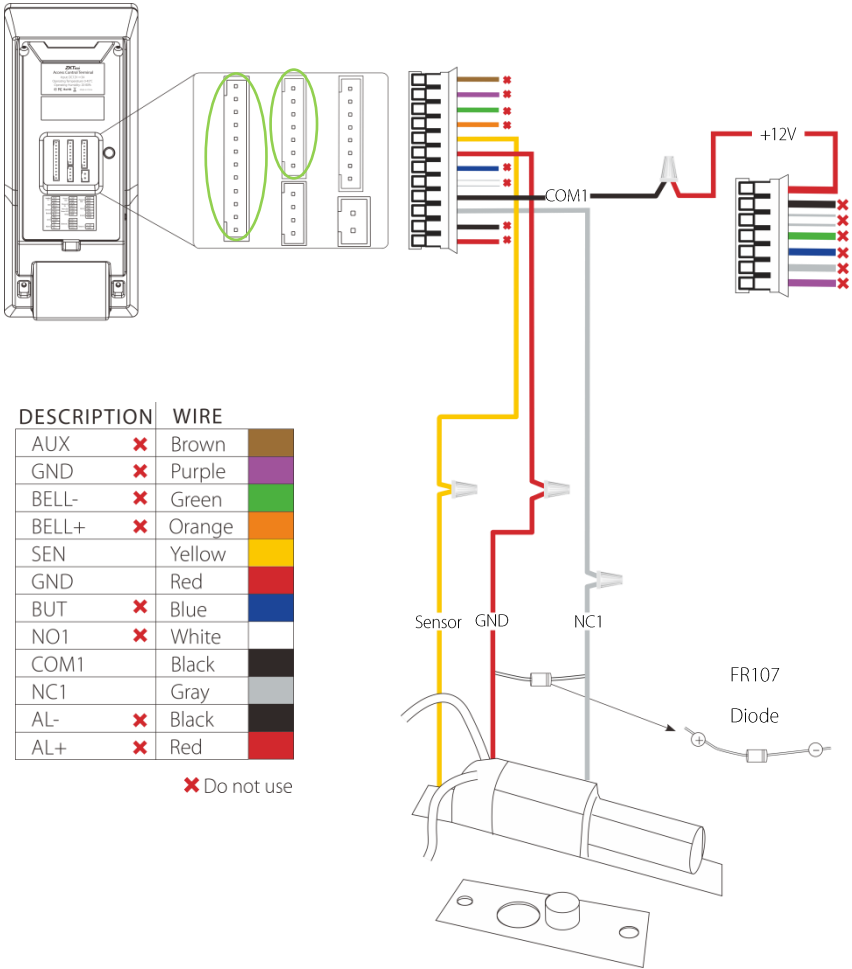

DESCRIPTION	WIRE	
AUX	✗	Brown
GND	✗	Purple
BELL-	✗	Green
BELL+	✗	Orange
SEN		Yellow
GND		Red
BUT	✗	Blue
NO1	✗	White
COM1		Black
NC1		Gray
AL-	✗	Black
AL+	✗	Red

✗ Do not use

Normally Closed Lock

Wiegand Output Connection

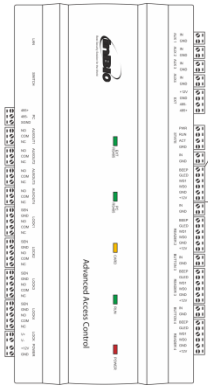
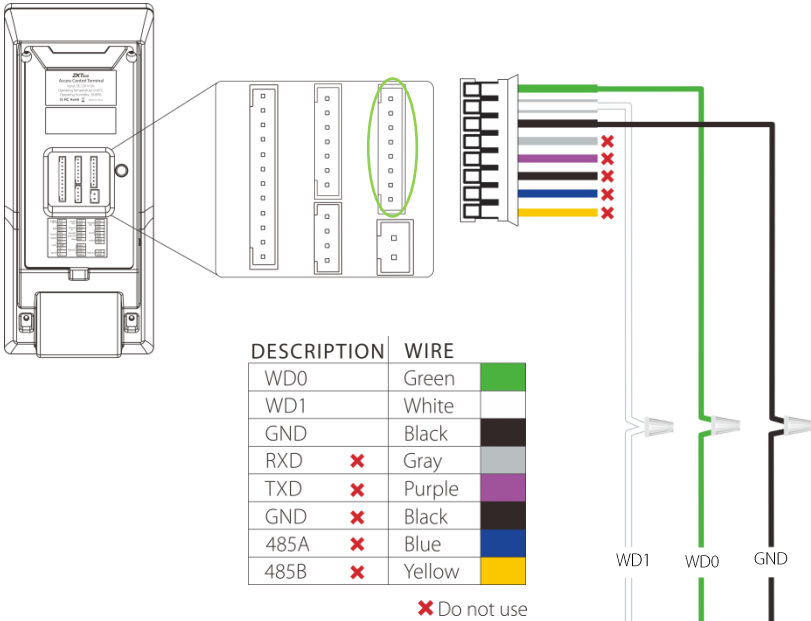

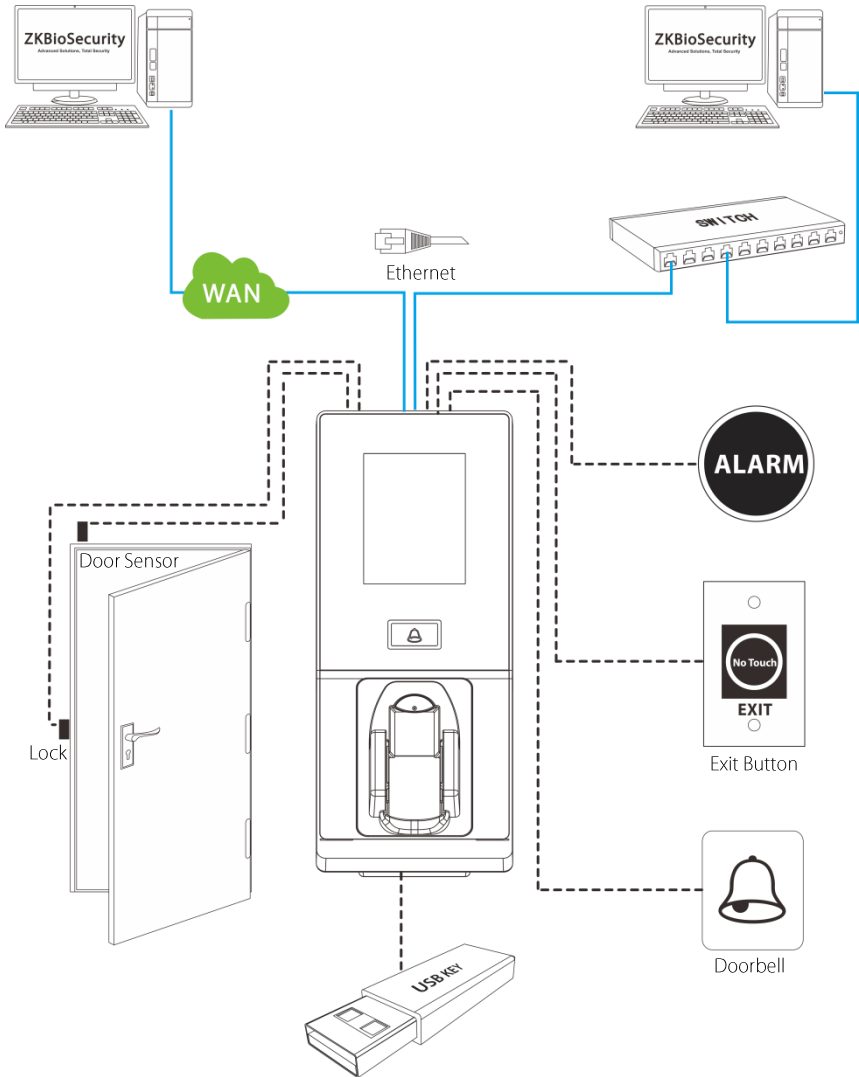

Standalone Installation

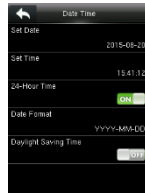
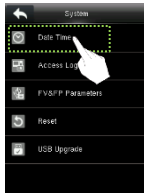

Device Operation

❖ Date / Time Settings



Press  icon to enter the main menu> System > Date Time to set date and time.

❖ Adding User

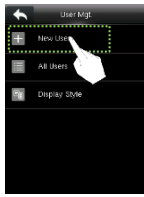

Press  icon to enter the main menu> User Mgt. > New User to enter the adding New User interface. Settings include inputting user ID, user name, choosing user role (Super Admin / Normal User), registering FV&FP★ / badge number★ / password, and setting access control role.

❖ Ethernet Settings

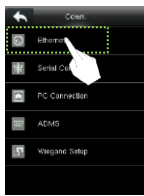

Press  icon to enter the main menu > Comm. > Ethernet.

The Parameters below are the factory default values. Please adjust them according to the actual network.

IP Address: 192.168.1.201

Subnet Mask: 255.255.255.0

Gateway: 0.0.0.0

DNS: 0.0.0.0

TCP COMM. Port: 4370

DHCP: Dynamic Host Configuration Protocol, which is to dynamically allocate IP addresses for clients via server. If DHCP is enabled, IP cannot be set manually.

Display in Status Bar: To set whether to display the network icon  on the status bar.

Device Operation

❖ ADMS Settings

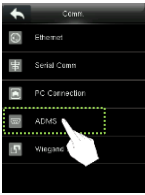

Press  icon to enter the main menu > Comm. > ADMS, to set the parameters which are used for connecting with the ADMS server.

When the Webserver is connected successfully, the initial interface will display the .

Enable Domain Name: When this function is turned on, the domain name mode "http://..." will be used, such as <http://www.XXX.com>. XXX denotes the domain name when this mode is on; when this mode is off, enter the IP address format in XXX.

Server Address: IP address of the ADMS server.

Server Port: Port used by the ADMS server.

Enable Proxy Server: Method of enabling proxy. To enable proxy, please set the IP address and port number of the proxy server. Entering proxy IP and server address will be the same.

Note: To connect the device to ZKBioSecurity software, Ethernet and ADMS options must be set correctly.

❖ Access Control Settings

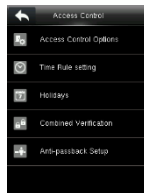
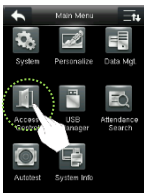

Press  icon to enter the main menu > Access Control to enter Access Control setting interface.

To gain access, the registered user must meet the following conditions:

1. User's access time falls within either user's personal time zone or group time zone.
2. User's group must be in the access combo (when there are other groups in the same access combo, verification of members of those groups are also required to unlock the door).

Access Control Options: To set parameters of the lock and other related devices.

Time Rule Setting: To set a maximum of 50 time rules. Each time rule consists of 10 spaces (7 spaces for one week and 3 holiday spaces), each space consists of 3 time periods.

Device Operation

Holidays: To set dates of holiday and the access control time zone for that holiday.

Combined Verification: To set access control combinations. A combination consists of a maximum of 5 access control groups.

Anti-Passback Setup: To prevent passing back which causes risks to security. Once it is enabled, entry and exit records must be matched in order to open door. In Anti-Passback, Out Anti-Passback and In / Out Anti-Passback functions are available.

➤ Access Control Combination Settings

E.g.: Add an access control combination which requires 2 persons' verification from both group 1 (set in User Management) and group 2.

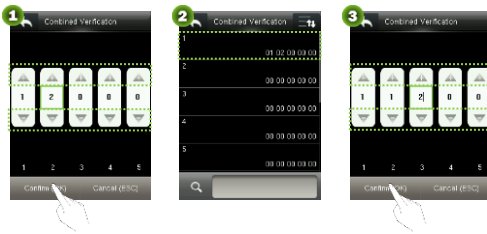

1. In "Combined Verification" List, click the desired combination to modify, and enter the interface (as shown in figure 1).
2. Click '+' / '-' to change the number, and click "Confirm" to save and back to "Combined Verification" (as shown in figure 2).

Note:

1. A single Access Control Combination can consist of a maximum of 5 user groups (in order to open door, verification of all 5 users is required).
2. If the combination is set as shown in figure 3, a user from access group 2 must obtain verification of two users from access group 1 in order to open door.
3. Set all group number to zero to reset access control combination.

Troubleshooting

1. "Invalid time zone" is displayed after verification?

- Contact Administrator to check if the user has the privilege to gain access within that time zone.

2. Verification succeeds but the user cannot gain access?

- Check whether the user privilege is set correctly.
- Check whether the lock wiring is correct.

3. The Tamper Alarm rings?

- To cancel the triggered alarm mode, carefully check whether the device and back plate are securely connected to each other, and reinstall the device properly if necessary.

Green Label

ZK Building, Wuhe Road, Gangtou, Bantian, Buji Town,
Longgang District, Shenzhen China 518129

Tel: +86 755-89602345

Fax: +86 755-89602394

www.zkteco.com

